

TX-28XD70F Operating Instruction

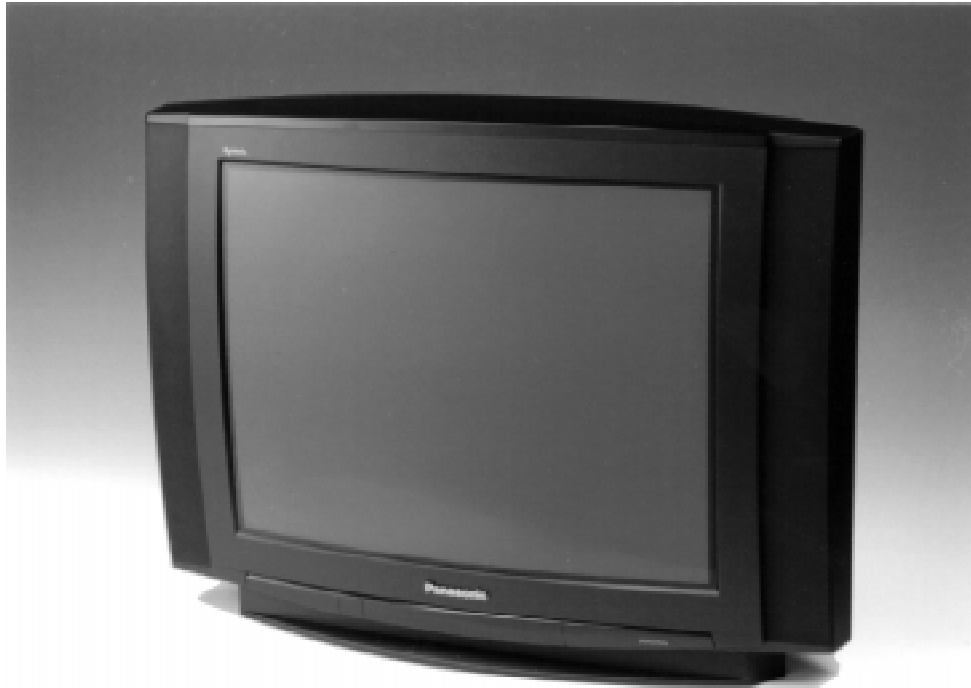

Panasonic



TX-28XD70F

100Hz

Quintrix



**TOP
TEXT**

Dear Panasonic Customer,
Welcome to the Panasonic family of customers. We hope that you have many years of enjoyment from your new colour television. This is a very advanced television, however, the Quick Start Guide will tell you how to have the TV operating quickly; you can then read the following pages to fully utilise the advanced features.



This television has a low power consumption making it very cost effective to run. To this end, the standby power consumption is merely 1 watt.

CONTENTS

Warnings and Precautions	2	Tuning Menu – Manual tuning	18
Quick Start Guide	3	OSD language	19
Basic Controls	4	AV Select and Setup	20
Using the On Screen Display Menus	5	VCR Operation	21
Aspect Control	6	Teletext Operation	22
Still Picture Controls	7	Audio / Video (AV) Connections	24
Main Menu	8	Via the front AV3 S–Video, Audio / Video (RCA) and Headphone Sockets	24
Sound Menu	9	SCART and S–Video Terminal Information ..	24
Setup Menu	10	Via the rear AV1 / AV2 / 21 Pin (SCART) and RCA Audio Out terminals	25
Tuning Menu	11	Trouble–shooting	26
Tuning Menu – Programme edit	12	For your guidance	27
Tuning Menu – Auto Setup	17	Specifications	27

WARNINGS and PRECAUTIONS

- This TV set is designed to operate on A.C. 220 – 240V, 50Hz.
- To prevent damage which might result in electric shock or fire, do not expose this TV set to rain or excessive moisture.
- **WARNING : HIGH VOLTAGE !!!**
Do not remove the rear cover as live parts are accessible when it is removed. There are no user serviceable parts inside.
- Avoid exposing the TV set to direct sunlight and other sources of heat.
- Remove the mains plug from the wall socket when the TV set is not used for a prolonged period of time.
- **CABINET AND PICTURE TUBE CARE**
Remove the mains plug from the wall socket. The cabinet and picture tube can be cleaned with a soft cloth moistened with mild detergent and water. Do not use solutions containing benzol or petroleum. TV sets can produce static electricity, care must be taken whenever touching the TV screen.
- Adequate ventilation is essential to prevent failure of electrical components, we recommend that a gap of at least 5cm is left all around this television receiver even when it is placed inside a cabinet or between shelves.

QUICK START GUIDE

Check that you have the accessories and items shown

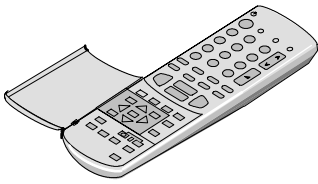

Remote Control Transmitter (EUR51923)



Batteries for the Remote Control Transmitter. (2 x R6 (UM3) size)



Operating Instruction book TQB8E2366U

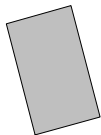

TV Guarantee

Remote control batteries

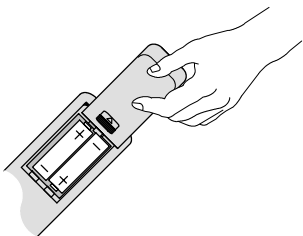

- Make sure that the batteries are fitted the correct way round.
- Do not mix old batteries with new batteries. Remove old, exhausted batteries immediately.
- Do not mix different battery types, i.e. Alkaline and Manganese or use rechargeable (Ni-Cad) batteries.

QUICK START ...

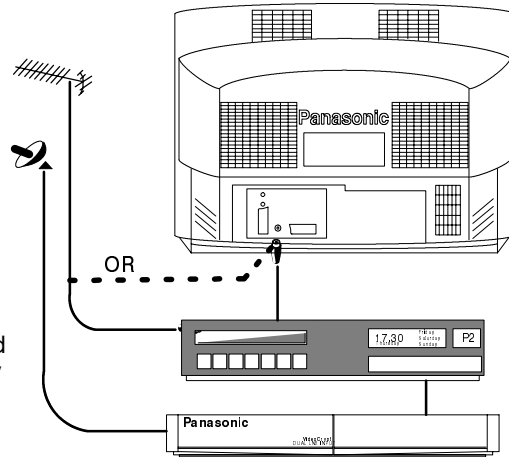

Plug in aerial and connect ancillary equipment see pages 24 and 25

Plug in T.V. and switch on

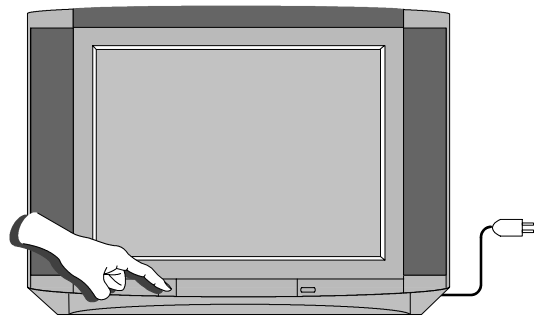

Select your country

Choose language also for Switzerland and Belgium only.

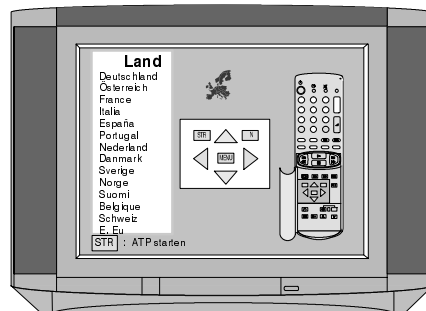

Auto setup will begin, your stations will be located and stored

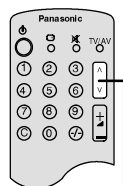
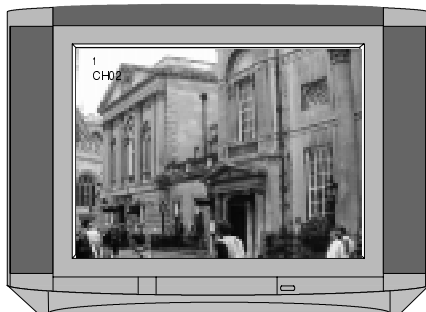
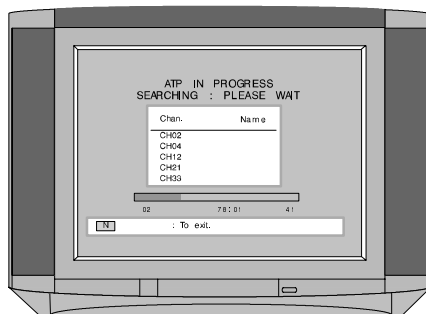

Change Channel

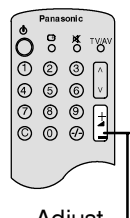

Adjust Volume

READY TO GO ...

BASIC CONTROLS – FRONT PANEL AND REMOTE CONTROL

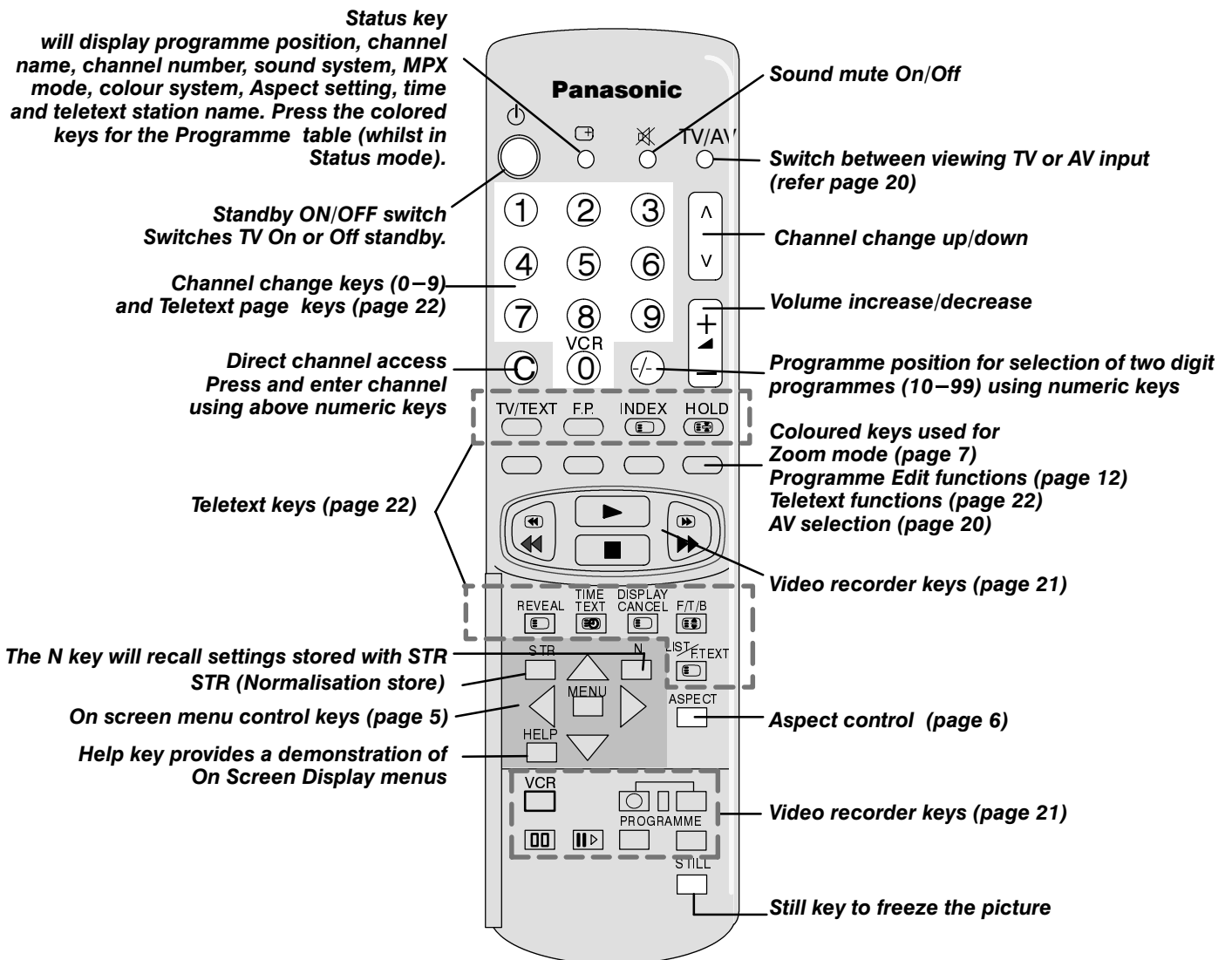
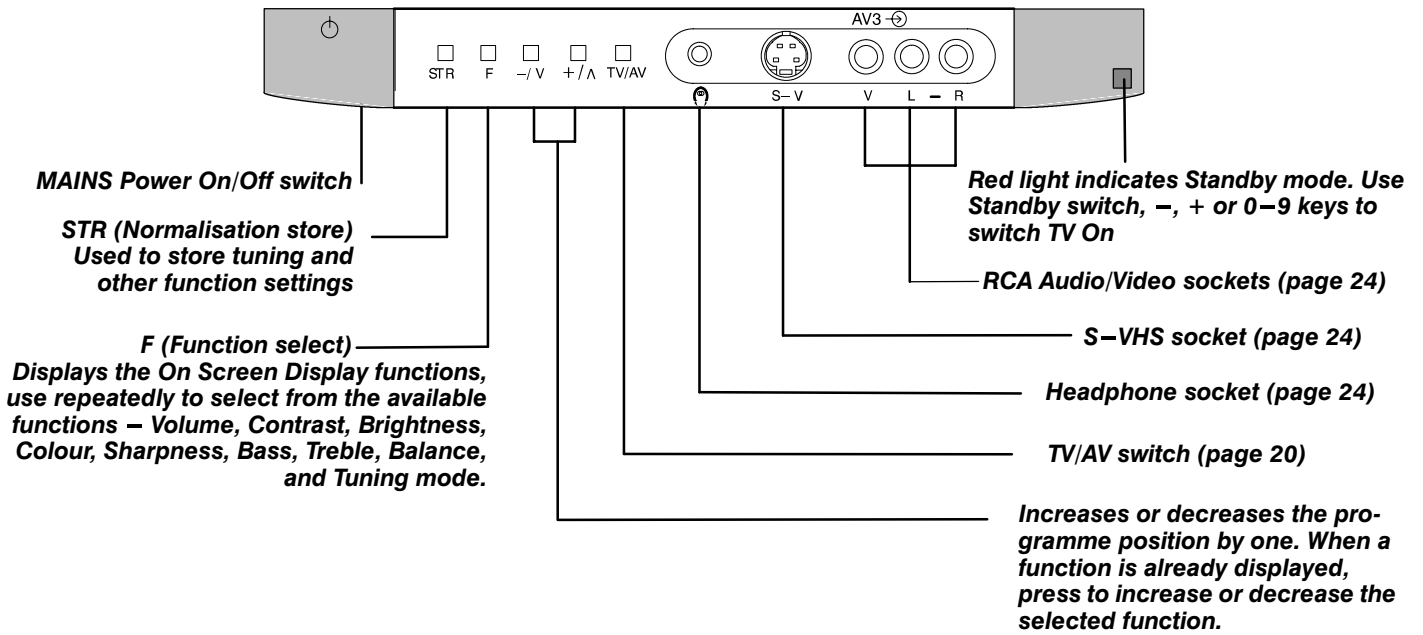

USING THE ON SCREEN MENUS

This TV has a comprehensive system of On Screen Display menus to access adjustments and options.

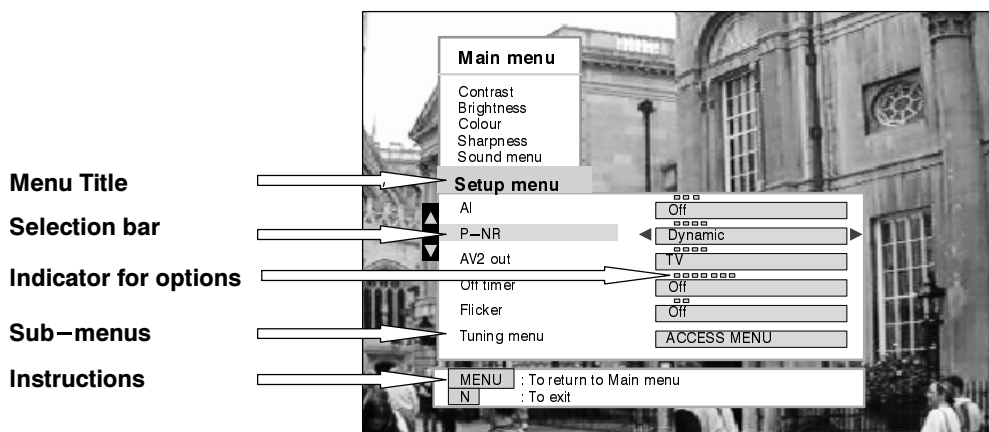

The following remote control keys are used to access and adjust settings for the On Screen Display menus.

Some selections, for example, **Contrast, Brightness, Colour** and **Sharpness** will allow you to increase or decrease their level.

Some selections, for example, **Off timer**, allow a choice to be made.

Some selections, for example **Tuning menu**, will lead to a further menu.

The **'MENU'** key is used to open the Main menu and also to return to either the Main menu or a previous menu.

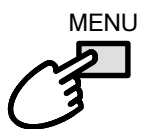

The **▲▼** keys are used to move the selector up or down the menus.

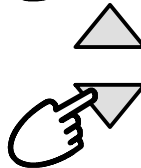

The **◀▶** keys are used to access menus, adjust levels or to select from a range of options.



The **'STR'** key is used to store settings after your adjustment or choice has been made.

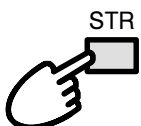

The **'N'** key is used to leave the menu system and return to the normal viewing screen.

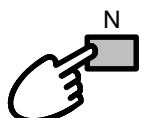

The **'HELP'** key will run a demonstration of the menus available.

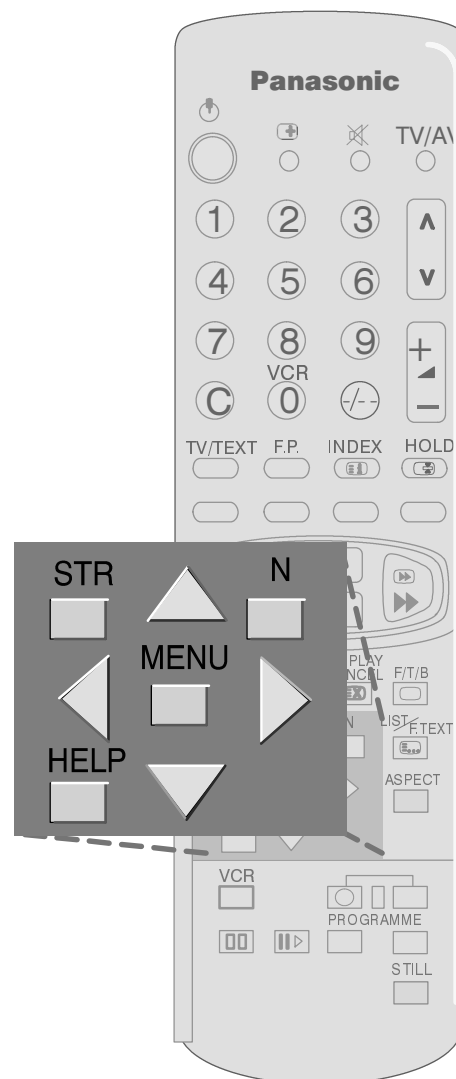

ASPECT CONTROLS

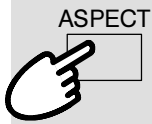

AUTO

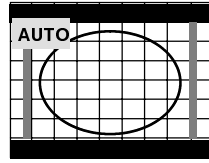

16:9

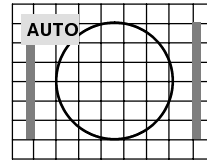

4:3

Selecting **AUTO** mode of this TV will automatically cause the TV to display any incoming picture at its correct format, i.e. 16:9 or 4:3.

4:3

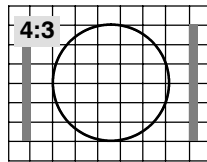

4:3 will display a 4:3 picture at its standard 4:3 size and can be selected if you wish to view in this format.

16:9

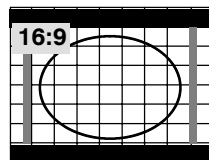

16:9 will display a 16:9 picture at its standard 16:9 size and can be selected if you wish to view in this format.

ASPECT CONTROLS

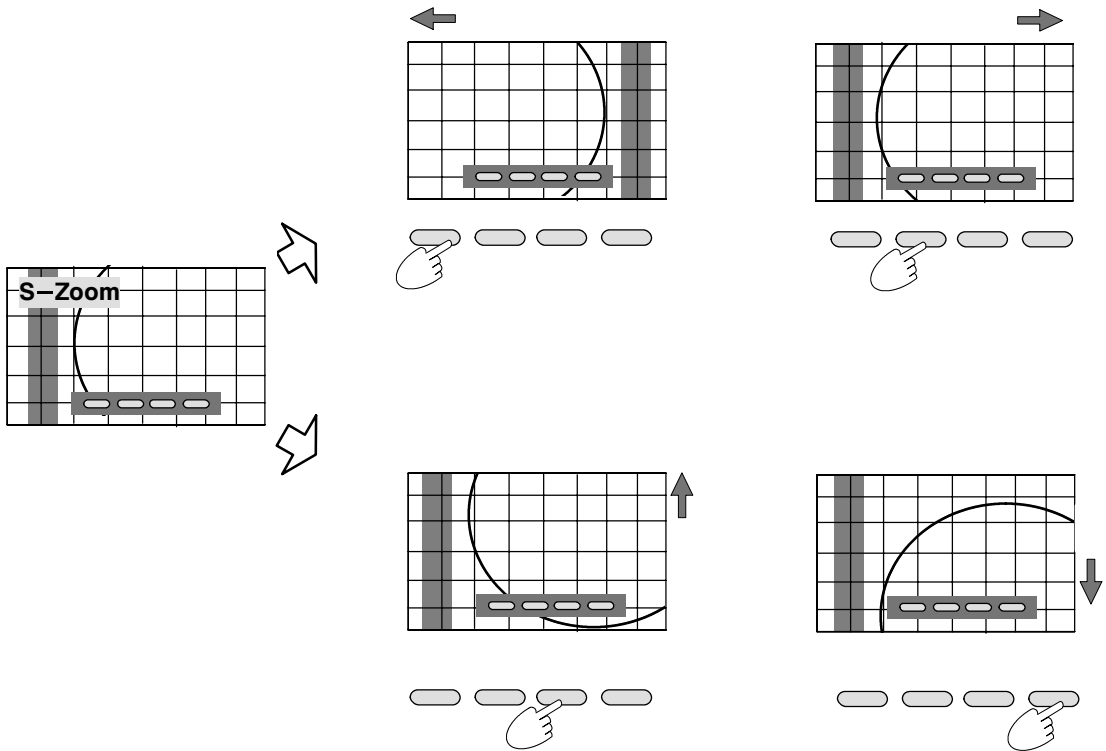
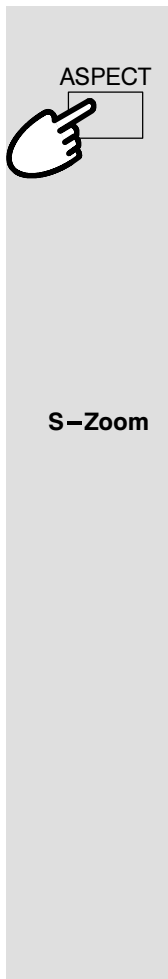

In **S-Zoom** mode the red and green keys will allow you to move the picture horizontally. The yellow and blue keys will allow you to move the picture vertically.

NOTE:

- The on screen selector keys that appear for some aspect functions will clear after a few seconds. If you subsequently wish to select an operation then press the Aspect key once more for the keys to reappear.
- A correct 16:9 picture format is only possible when a 16:9 signal is received through the 21 pin terminals. It is possible to switch a normal 4:3 signal into 16:9 mode, but this is for effect only and does not accurately represent the 16:9 picture format.

STILL PICTURE CONTROLS

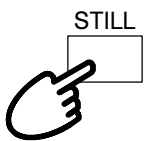

The STILL key allows you to freeze the picture at any time.

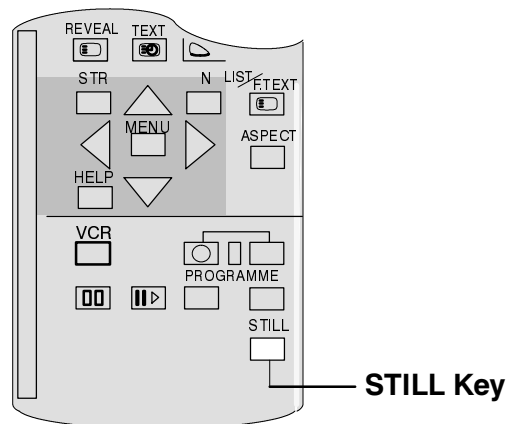

MAIN MENU

All menus start from the Main menu (except AV select and Tuning procedure (Front panel)). You will also find the basic picture quality adjustments within this menu.

Open the Main menu



Move to your choice



Access your choice



Increase or decrease levels or move to the Sound, Setup or OSD languages menus.

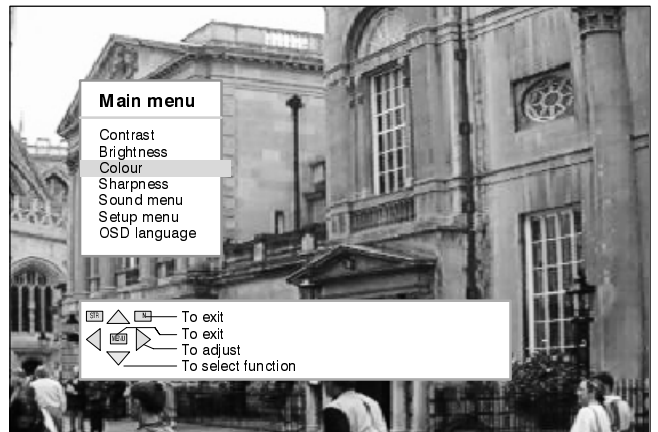
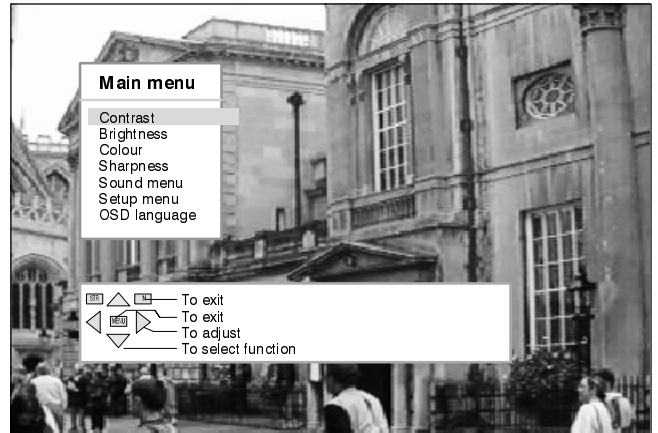
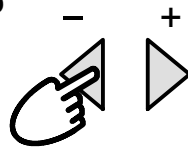

Contrast

The Contrast level of the TV can be adjusted, to suit the lighting conditions of the room, as necessary.

Brightness

The Brightness level can be adjusted to suit your viewing conditions.

Colour

The Colour level can be adjusted to your own preference.

Sharpness

The picture can be softened or sharpened to your own preference.

Tint

The Tint adjustment will only appear as a menu item if you have an NTSC signal source connected to the TV and will allow adjustment of the hue.

Sound Menu

Choosing the Sound menu will take you to that menu and allow adjustments to the sound quality.

Setup Menu

Choosing the Setup menu will lead to the Setup menu for various feature adjustments.

OSD language

The OSD language menu will allow you to change the language used for all on screen menus.

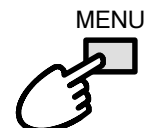

To close Main menu

SOUND MENU

The Sound menu will allow you to set your personal preferences for all aspects of sound quality

Open the Main menu

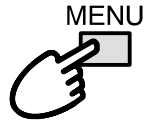

Move to Sound menu



Access Sound menu



Move to your choice



Increase or decrease levels or choose from options of MPX, Mode or ambience.

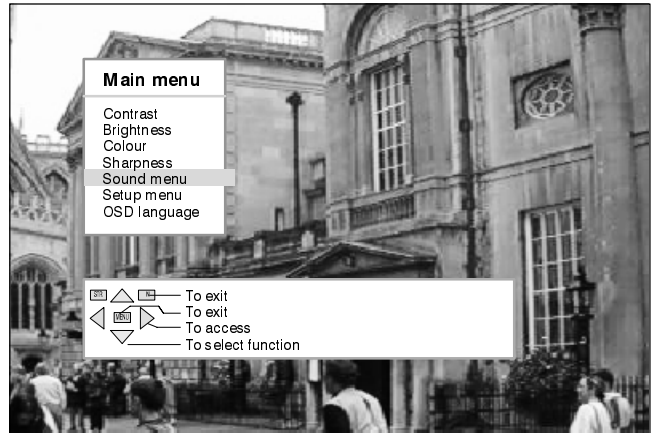
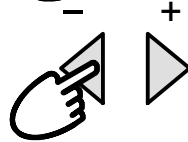

Bass

Bass adjustment will emphasise the lower, deeper frequencies and can be increased or decreased.



Treble

Treble adjustment will emphasise the sharper, higher frequencies and can be increased or decreased.



Balance

Balance affects the levels of sound between the left and right speakers. Adjustment can be made so that the level from between speakers will suit your listening position.



The headphone volume can be adjusted independently of the TV speakers so that everyone can enjoy listening at their own comfort level.

MPX

MPX will usually be set to Stereo to provide the best reproduction, however if reception deteriorates or if the service is not available then it is advisable to switch to Mono. Mono (M1) and (M2) can also be selected if signals are being transmitted.

Mode

The sound can be improved during Music or Speech mode by selecting the appropriate function.

Ambience

Ambience provides a dynamic enhancer to give a greater depth of sound, you can choose to switch On or Off.

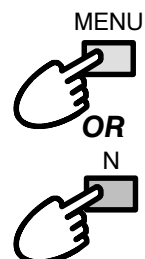
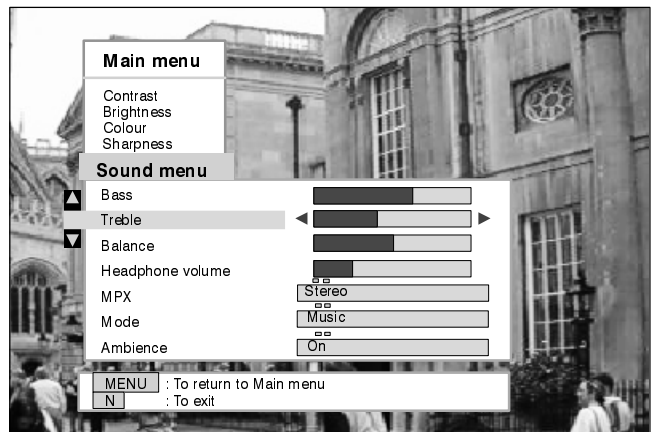

Return to Main menu

To exit menu system

SETUP MENU

The Setup menu provides access to various advanced features and also to the Tuning menu

Open the Main menu

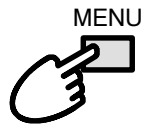

Move to Setup menu



Access Setup menu



Move to your choice



Increase or decrease levels or choose from options

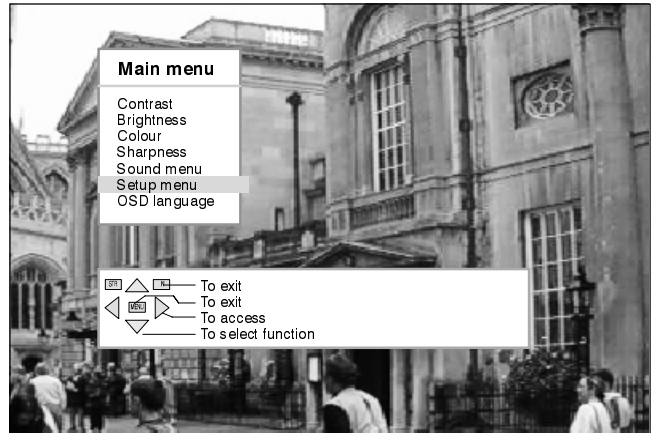
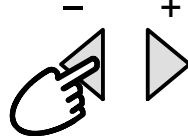

AI

AI automatically analyses the incoming picture and processes it to give improved contrast, optimum field of depth and vivid colour tones. Choose either Off or from two levels of application.

P-NR

P-NR will automatically reduce unwanted picture interference. Choose either Off or one of 3 levels of application.

AV2 out

AV2 offers you a choice of signals to send to the AV2 SCART socket. You can choose from the current **TV** programme position, the signal entering **AV1/AV3** or **Monitor** – the picture displayed on screen.

Off timer

Off timer will switch the TV off within a preset time which you can choose from between 0 to 90 minutes in 15 minute intervals.

Flicker

You will normally find that **Flicker** is best set to ON to reduce any slight picture movement. However, it is possible that some occasional broadcasts may benefit by selecting the OFF position.

Tuning menu

The Tuning menu provides an entry to many other features including Programme edit, ATP, Fine tuning, Colour system, and Text language.

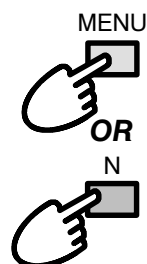
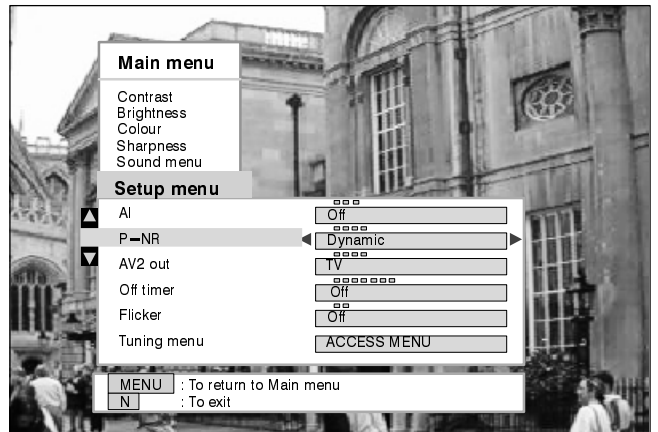

Return to Main menu

To exit menu system

TUNING MENU

The Tuning menu provides access to both manual and automatic tuning menus

Open the Main menu



Move to Setup menu



Access Setup menu



Move to Tuning menu



Access Tuning menu



Move to your choice



Increase or decrease levels or choose from options

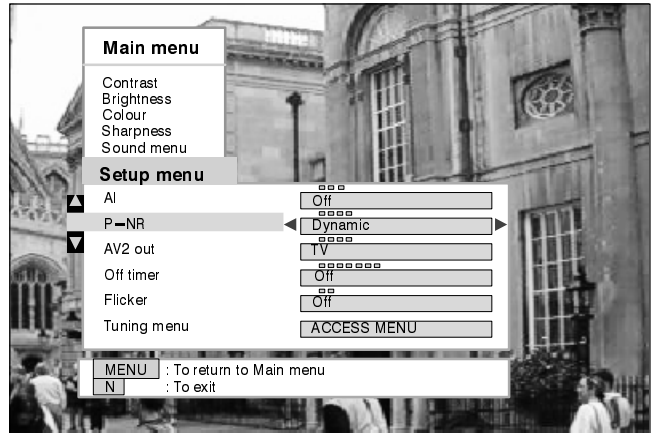
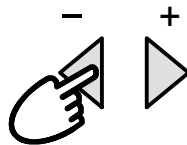

Programme edit

Accessing Programme edit menu will allow stations to be moved, added, deleted, named, locked and provides access to the TV –system. Further details on page 12.

Auto setup

The Auto setup menu allows you to automatically retune the TV. Further details on page 17.

Manual tuning

The Manual tuning menu allows individual programme positions to be tuned manually. Further details on page 18.

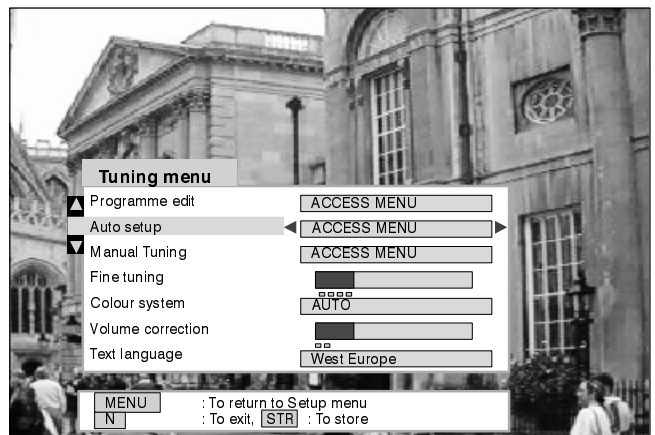

Fine tuning

Stations can be finely tuned using the Fine tuning adjustment.

Colour system

The Colour system menu allows you to decide the correct choice of transmission standard.

Volume correction

Volume correction allows you to adjust the volume level of individual stations.

Text language

You can choose either West Europe or East Europe to provide the most suitable characters to be used for your Teletext viewing.

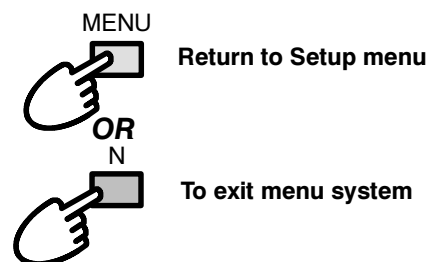

TUNING MENU – Programme edit

The Programme edit menu allows you to delete, add, move, view, etune, name and lock channels and to change the TV-system

Open the Main menu

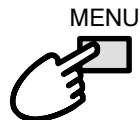

Move to Setup menu



Access Setup menu



Move to Tuning menu



Access Tuning menu

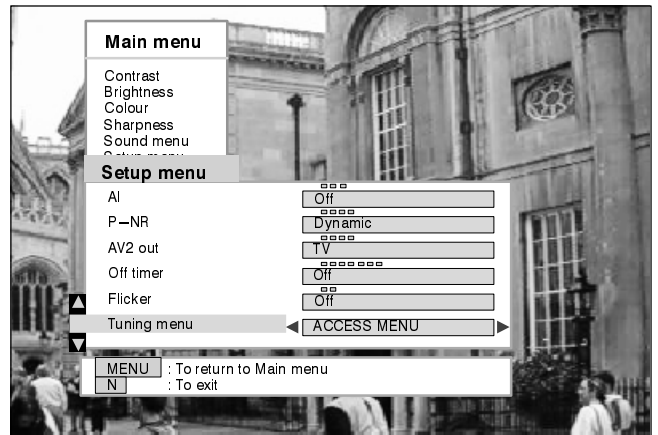

Move to Programme edit



Access Programme edit

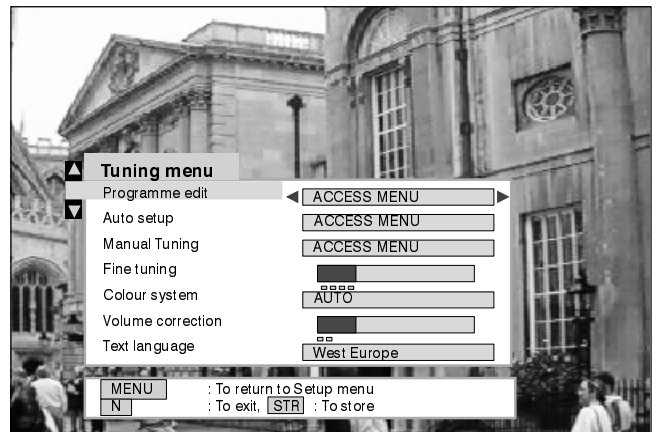

To delete an unwanted programme position

Choose the programme position



Press the red key on remote control



Press STR to delete

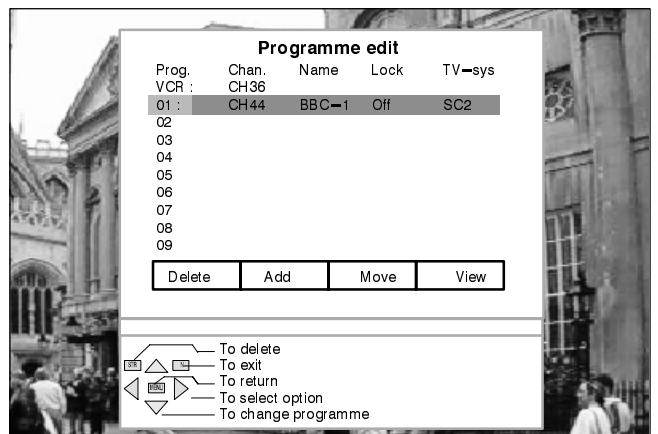

If you have completed changes to the Programme edit menu then

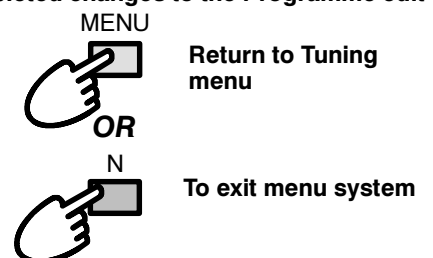

TUNING MENU – Programme edit

To add a programme position

Choose the programme position



Press the green key



Press STR to add

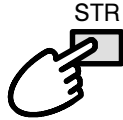

This blank programme can then be tuned, named, locked and be allocated your choice of TV-system

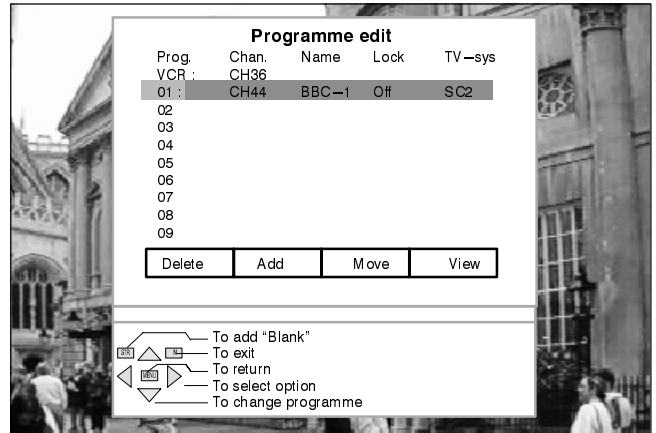

If you have completed changes to the Programme edit menu then

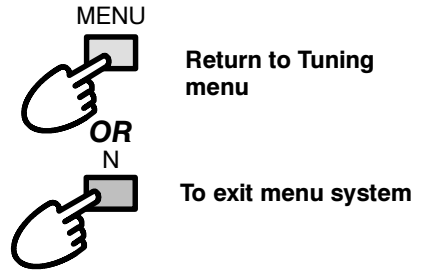

To move a programme to another position

Choose the programme position



Press the yellow key on remote control

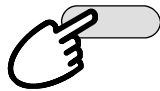

Choose new position

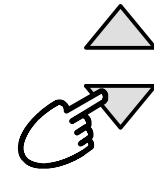

To action new position



Press STR to store

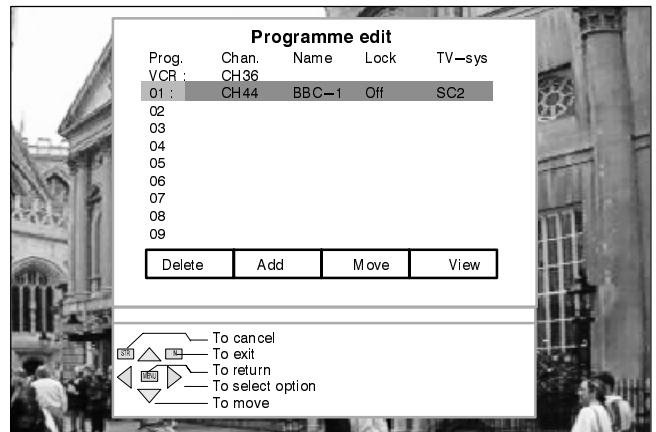
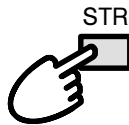

If you have completed changes to the Programme edit menu then

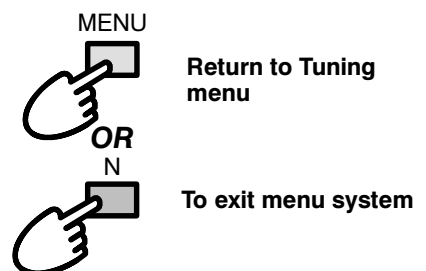

TUNING MENU – Programme edit

To view a programme position

Choose the programme position



Press the blue key on remote control

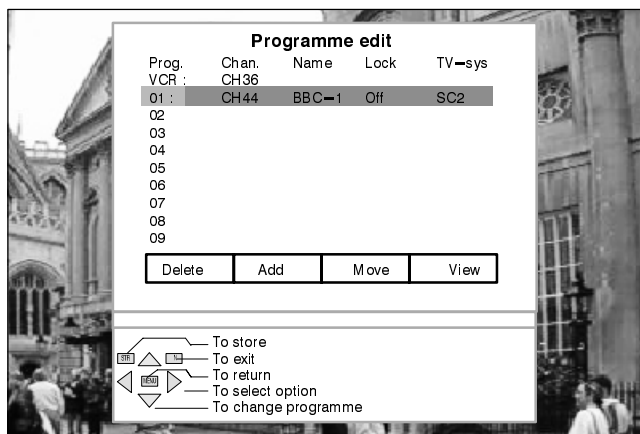

The screen will return to Programme edit after a few seconds

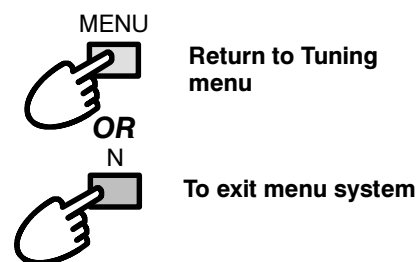
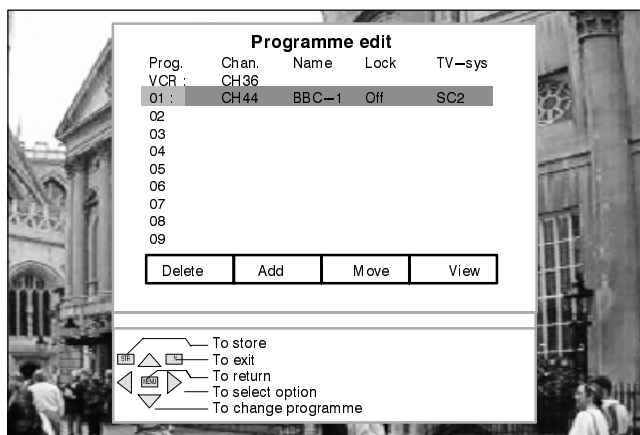
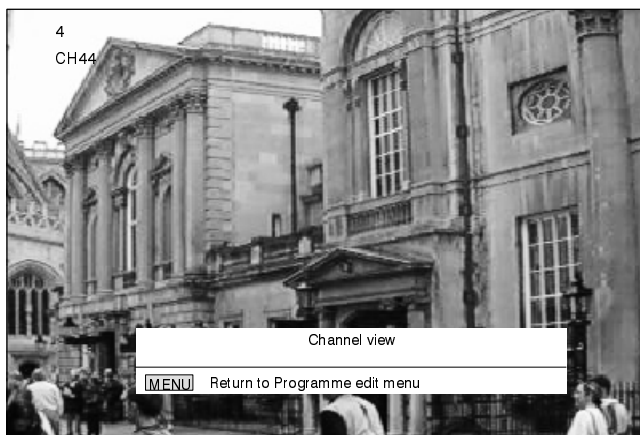

TUNING MENU – Programme edit

To tune a programme position

Choose the programme position



Move to the channel setting

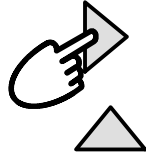

Increase or decrease channel number



Press STR to store

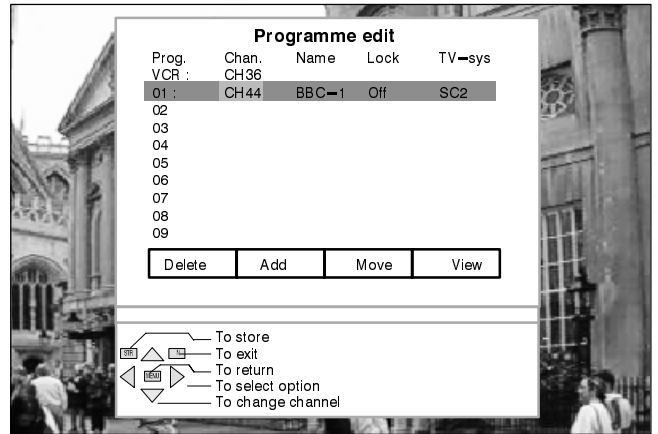
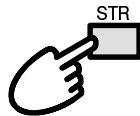

If you have completed changes to the Programme edit menu then

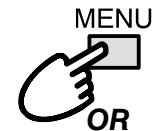

Return to Tuning menu

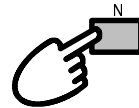

To exit menu system

To rename a programme position

Choose the programme position



Move to the Name position



Choose the new character



Move to the next character position

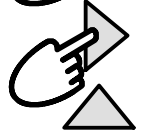

Continue until renaming is completed



Press STR to store

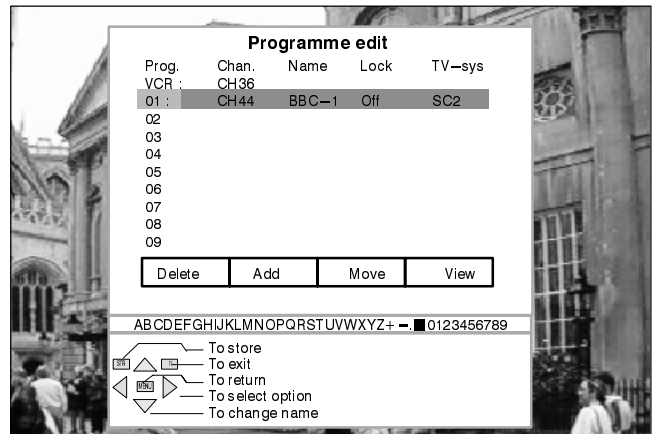
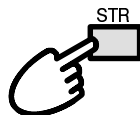

If you have completed changes to the Programme edit menu then

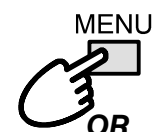

Return to Tuning menu

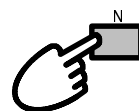

To exit menu system

TUNING MENU – Programme edit

To lock a programme position to prevent access

Choose the programme position



Move to the lock position



Choose between lock on or lock off



Press STR to store

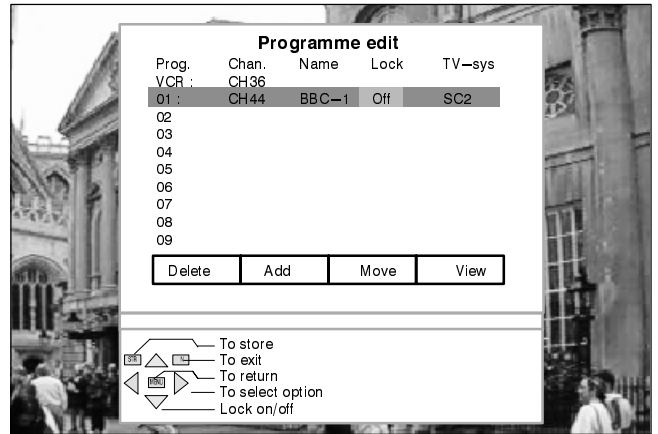
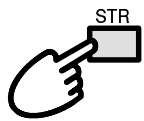

If you have completed changes to the Programme edit menu then

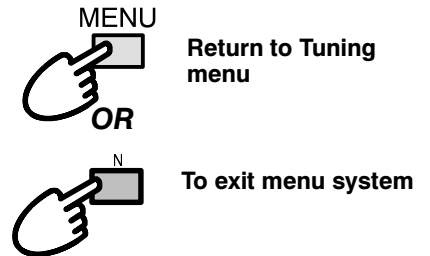

To change the TV-system for a programme position

Choose the programme position



Move to the TV-sys position

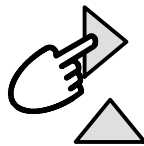

Choose the required sound system *



Press STR to store

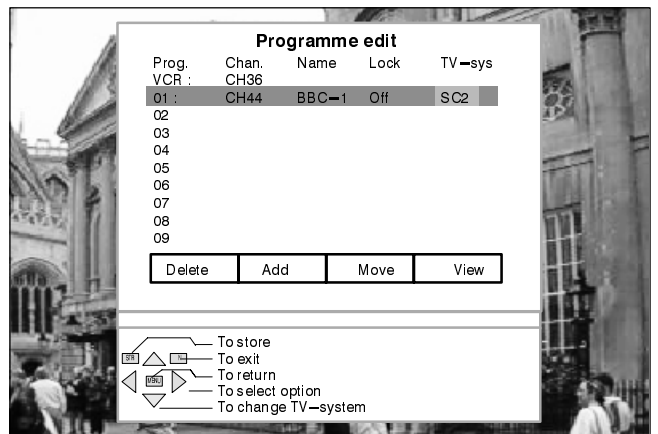
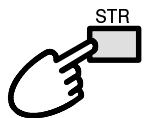

If you have completed changes to the Programme edit menu then

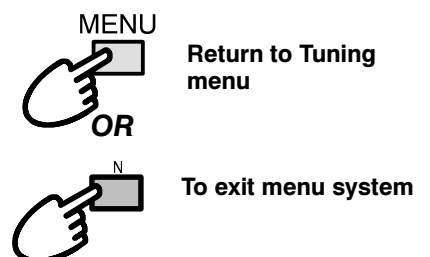

- * SC1 : PAL B, G, H / SECAM B, G
- SC2 : PAL I
- SC3 : PAL D, K / SECAM D, K
- F : SECAM L / L'

TUNING MENU – Auto setup (ATP)

The Auto setup menu will allow you to automatically retune the TV to your local stations. It is useful if you move to a different region.

Open the Main menu

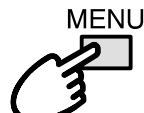

Move to Setup menu



Access Setup menu



Move to Tuning menu



Access Tuning menu



Move to Auto setup menu



Access Auto setup menu



Press to start Auto setup (ATP)

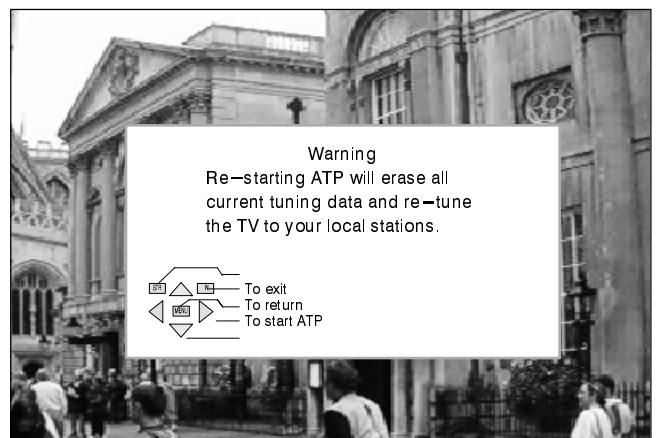
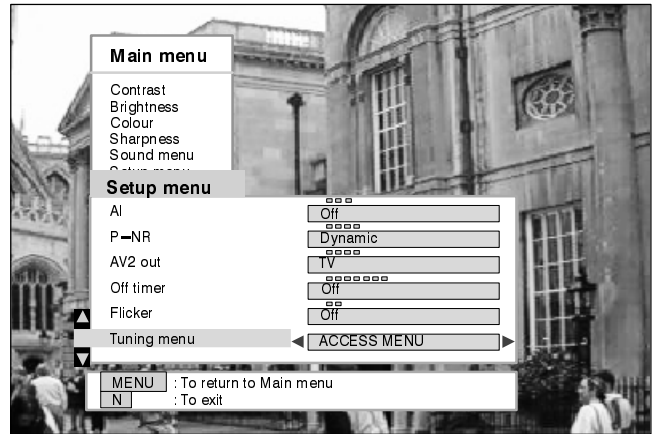

Select your country



Press to start Auto setup (ATP)



The TV will search for, locate and order your local stations.

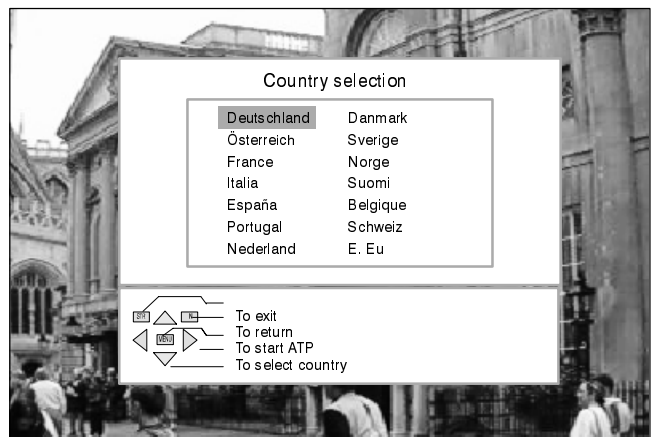

Press Menu to return

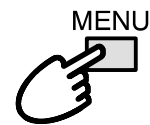

Press N to exit

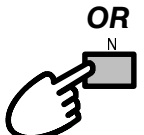

Once this operation is completed the TV will display programme position 1.

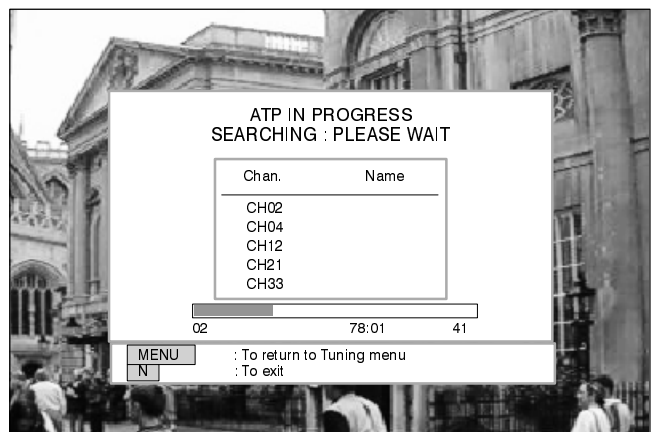

TUNING MENU – Manual tuning

Manual tuning of the Programme positions is available either from the on screen display menu or from the front panel controls

Manual tuning menu

Open the Main menu

Move to Setup menu

Access Setup menu

Move to Tuning menu

Access Tuning menu

Move to Manual tuning

Access Manual tuning

Select the programme position

Start tuning

Press STR to store

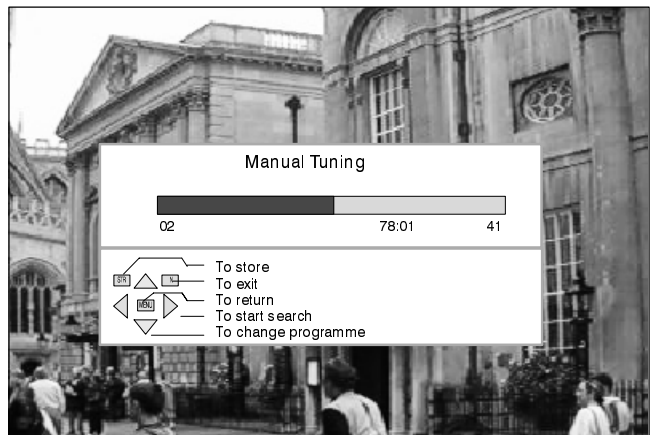
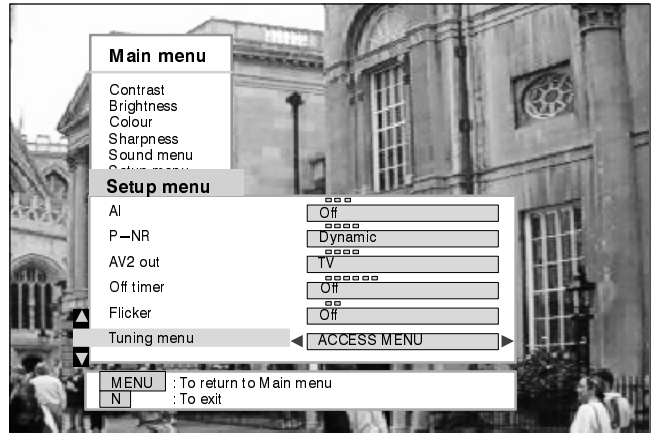
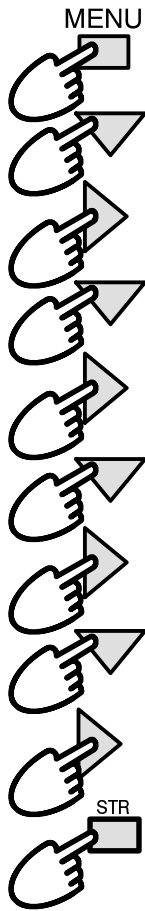

Manual tuning (Front panel)

Press the F button (Front panel) until "Tuning mode" is reached

Press the - or + button to access "Tuning mode"

Press the TV/AV button to change to the required programme position

Press the - or + button to start the tuning search

Press STR to store changes

Press the F button to exit

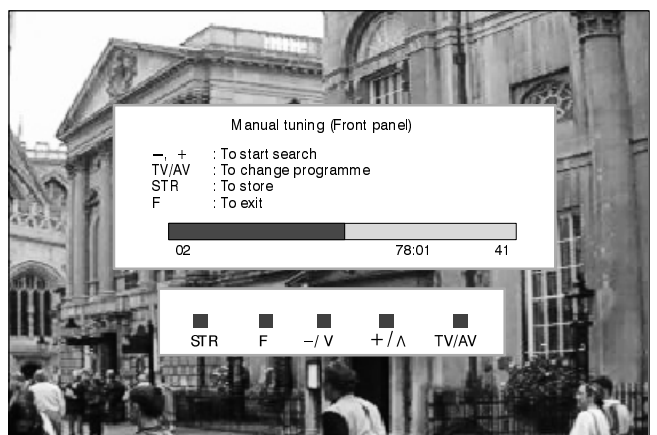
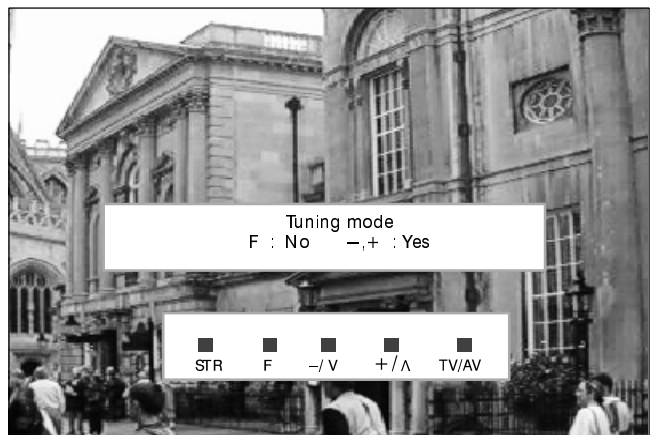
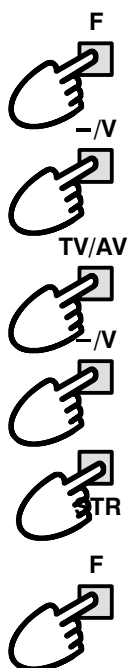

OSD LANGUAGE

When you first installed the TV the on screen display language was set according to your choice of country. If you wish to use a different language then it can be chosen from the OSD language menu.

Open the Main menu

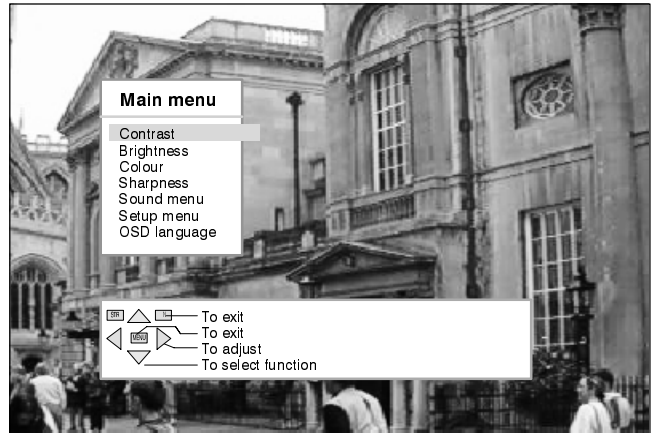
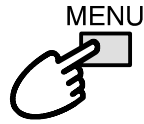

Move to the OSD language menu

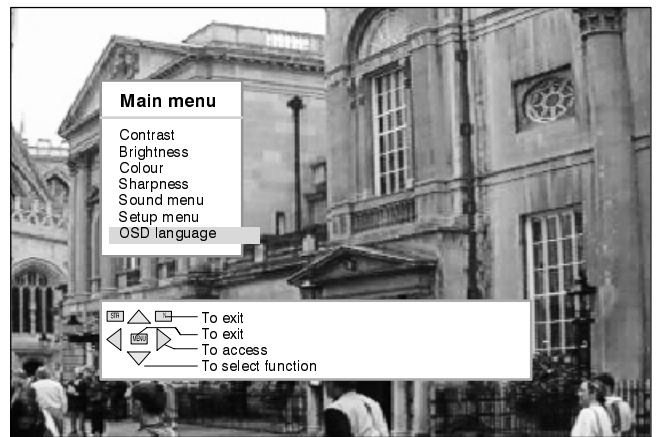

Access your choice

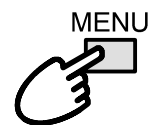
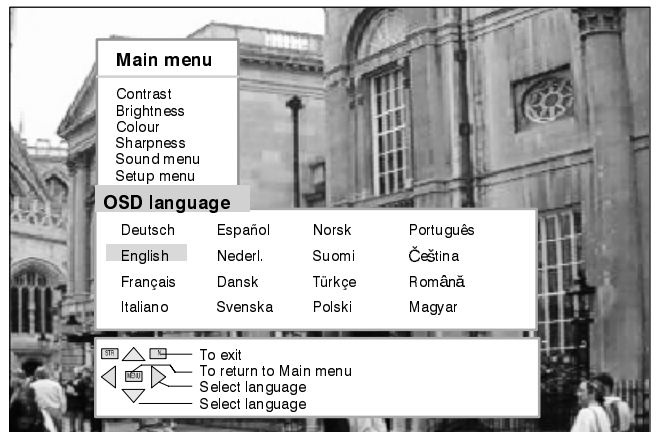
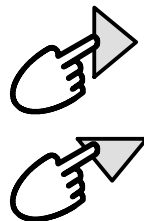

Return to Main menu

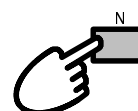

To exit menu system

AV SELECT and SETUP

The AV Select menu will allow you to choose which AV source to view.

Press the TV/AV key
(remote control or TV)

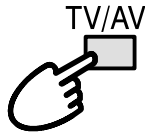

Press the appropriate coloured key of remote control (whilst the options remain on screen)



The options will disappear

You may wish to make adjustments to the Setup or Sound menus

Setup menu

Open the Main menu

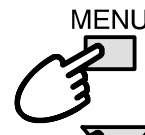

Move to Setup menu



Access Setup menu



Move to your choice



Access adjustments or options



Sound menu

Open the Main menu



Move to Sound menu



Access Sound menu



Move to your choice





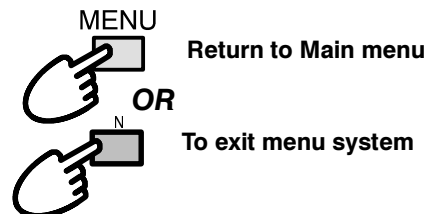
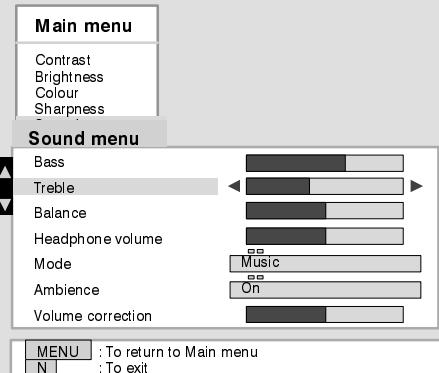
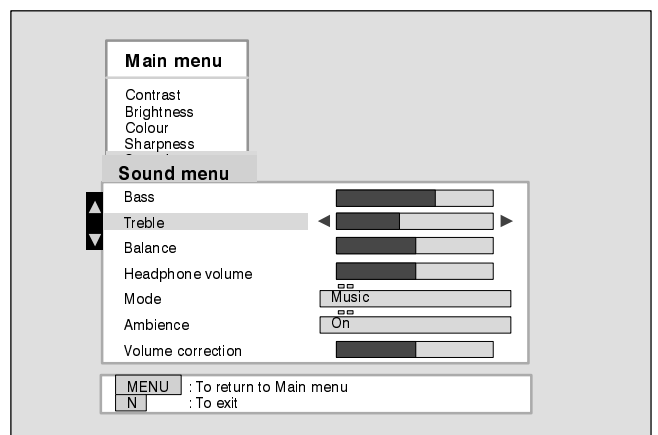
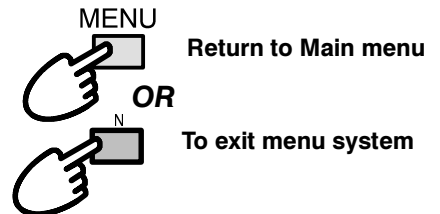
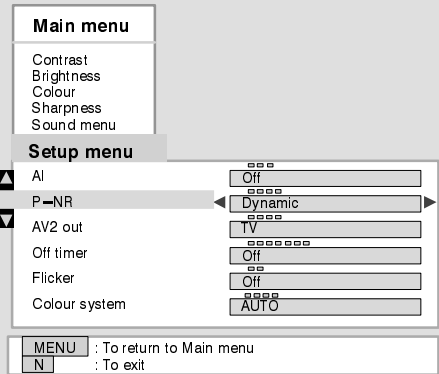
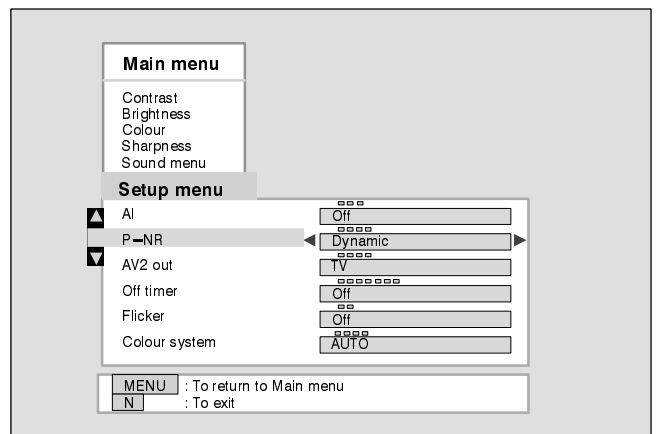





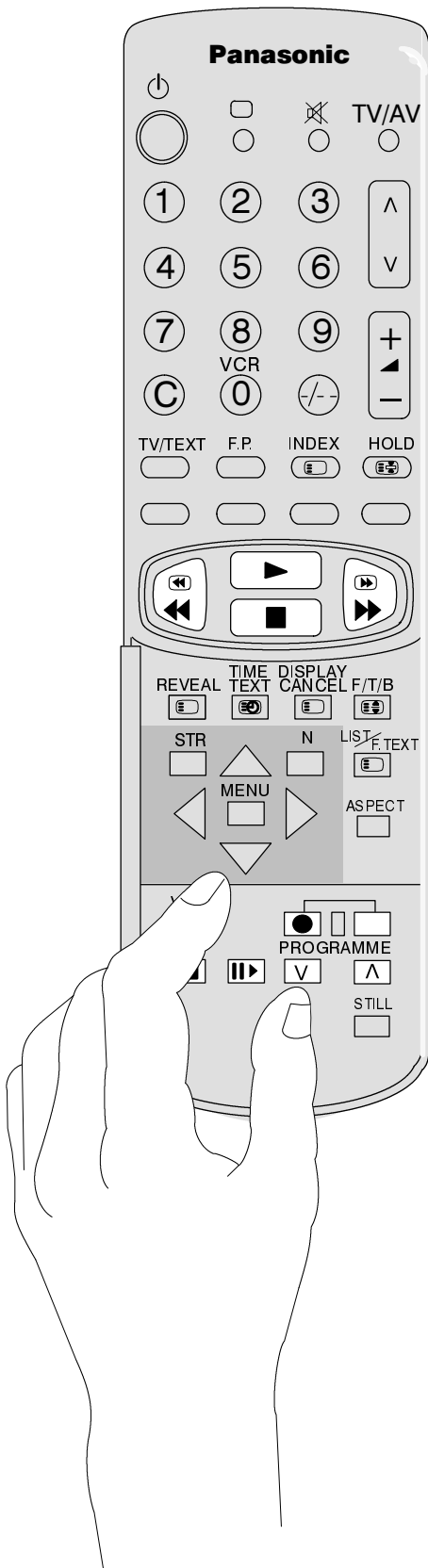

Access adjustments or options



VCR CONTROL

The Remote Control is capable of operating some functions of selected Panasonic VCRs, please consult your dealer for details. Some VCR have different functions, so to ensure compatibility, please refer to the VCR's instruction book.

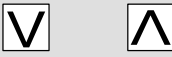

	<p>VCR</p> <p>Standby Press to switch the VCR to standby mode. Press again to switch back on.</p>
	<p>Play Press to playback the tape.</p>
	<p>Stop Press to stop the tape.</p>
	<p>Fast Forward / Cue Press to fast forward the tape. In Play mode, press to view the picture rapidly forward.</p>
	<p>Rewind / Review Press to rewind the tape. In Play mode, press to view the picture in reverse rapidly.</p>
	<p>Pause / Still Press in playback mode, the picture will pause.</p>
	<p>Still Advance While in PAUSE / STILL mode, press to advance the picture one frame at a time.</p>
	<p>Programme Up / Down Press to increase or decrease the VCR programme position by one.</p>
	<p>Record Press these together to record.</p>

TELETEXT OPERATION

- Teletext features may vary depending on the Broadcasting Companies and is only available if the channel selected is transmitting Teletext.
- This TV set is capable of receiving German TOP Teletext transmissions, it will automatically switch to them if they are being received. This will be indicated in the display area at the bottom of the screen.
- Pressing the **MENU** key whilst in Teletext operation will display the contrast function with a cyan bar, press ◀ ▶ to alter the setting as required.
- When in teletext mode, the volume may still be altered to the desired listening level.

What is LIST mode?

In LIST mode, four differently coloured page numbers are situated at the bottom of the screen. Each of these numbers can be altered and stored in the TV's memory.

What is FASTEXT?

In FASTEXT mode, four differently coloured subjects are situated at the bottom of the display. To access more information about one of these subjects, press the appropriately coloured button. This facility enables fast access to information of the subjects shown.

What is TOP Teletext?

TOP stands for TABLE OF PAGES or 'Teletext without problems'

TOP Teletext is a new development to make the task of selecting the desired Teletext pages easier and shorter. In fact page access time is instantaneous, just press the button and the page appears.

How does it work?

TOP uses the four coloured keys, Red, Green, Yellow and Blue to select the following information.

- The Red key will select the next available page DOWN.
- The Green key will select the next available page UP.
- The Yellow key selects pages within a group, each time the Yellow key is pressed the topic within the group will change, for example you could change from an Economic topic to a CULTURAL topic by using this key. With the Red and Green keys selection of the next available pages DOWN and UP is possible within the CULTURAL topic.
- A larger jump from group to block is possible by use of the Blue key, this could be a SPORT topic for example. Within this SPORT topic it is possible to select different groups such as Tennis, Football, Baseball etc, using the Red and Green keys the next available pages DOWN and UP can be selected.

What are the advantages?

- Page selection at the touch of a single key.
- Easy to use step-by-step selection of the topical subject.
- Reduction of waiting time.
- If non-existent page number is entered, a question mark will appear at the bottom of the screen.
- Page status line at bottom of screen so you always know which key will take you to the desired information.

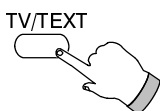

TV / Teletext mode

Press the **TV/TEXT** key.
The screen will display the Teletext page.
Press again when you wish to return to TV. mode.

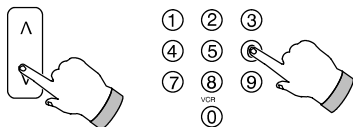

Page Selection

Pages can be selected in two ways :
a. Press the Up / Down keys to increase or decrease the page number by one.
b. By entering the page number, using 0 –9 on the remote control.

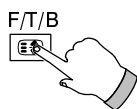

Full / Top / Bottom

Press to expand the TOP half of the page.
Press again to expand the BOTTOM half.
Press again to return to normal (FULL) size.



Reveal

Press to reveal hidden words e.g. quiz page answers.
Press again to hide.

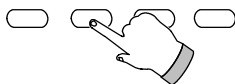

Red / Green / Yellow / Blue keys

In TOP or FASTEXT mode these correspond to the differently coloured subjects.
In LIST mode they correspond to the differently coloured page numbers.

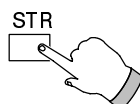

List Store

In LIST mode the four page numbers can be altered for channel positions 1 – 25 only.
To do this, press one of the coloured keys and enter the new page number.
Press and hold **STR**, the page numbers will change colour.

TELETEXT OPERATION

It is not possible to change the programme position when in News flash, Update or Sub Coded Page Access operation.



List / F.text (List / Top)

When in List / Top operation

Press to change from TOP mode to LIST operation and vice versa.

When in List / Fastext operation

Press to change from FASTEXT mode to LIST mode and vice versa.

In FASTEXT mode four differently coloured subjects are displayed at the bottom of the page. Press the appropriate coloured key to access more information about one of these subjects.

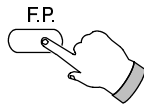

Favourite Page (F.P.)

Stores a favourite page in memory for instant recall. To store such a page, the TV must be in LIST mode, and the programme position must be from 1 – 25. Press the **BLUE** key, select the page number, then press **STR**. The page number is now stored. Press **F.P.** to recall this page.

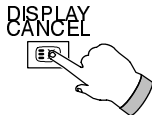

Display Cancel

Press **DISPLAY CANCEL** to view the TV picture whilst searching for a Teletext page. When found, the screen will display the page number at the top left. Press **DISPLAY CANCEL** to view the page. Press **TV / TEXT** to return to normal TV operation.

News Flash

When a news flash page has been selected, press **DISPLAY CANCEL** to view the TV picture, when an update is received, it will be displayed on screen. Press **DISPLAY CANCEL** to remove updated news. Press **TV / TEXT** to return to normal TV operation.

Update

Press **DISPLAY CANCEL** to see the update of information on certain pages. When an update is received, the page number will be displayed at the top left of the screen. Press **DISPLAY CANCEL** to view the page. Press **TV / TEXT** to return to normal TV operation.



Sub Coded Page Access

When teletext information exceeds more than one page, it may take some time for the automatic changing of the sub pages to reach the sub page you require. It is possible to enter your required sub page and continue watching the normal programme until the correct sub page is found. Select the required page number using keys 0 – 9.

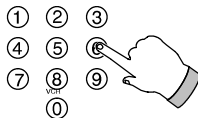

Press **TIME TEXT**, **** will be displayed (top right of the screen).

Enter desired sub page number before the **** disappears. To select page 6 enter 0, 0, 0 and 6.

If in LIST mode, a 'T' will appear in the current box at the bottom.

Press **DISPLAY CANCEL** to view a normal TV programme.

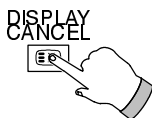

When the page is available, press **DISPLAY CANCEL** to view the page. To clear the page perform one of the following :

- Select a new page number.
- Press **TV/TEXT** to return to normal TV operation.



Index

When in TOP operation

Press **INDEX** to display the PANASONIC INDEX Directory. Press **RED / GREEN** to move the cursor UP / DOWN. Press **YELLOW** to move to next directory page. Press **BLUE** to view the selected subject. Press **INDEX** key to return to main index.

When in FASTEXT operation

Press **INDEX** to return to the main index page.

AUDIO/VIDEO CONNECTIONS

Front AV3 4 Pin S-Video, RCA Audio / Video and Headphone Sockets

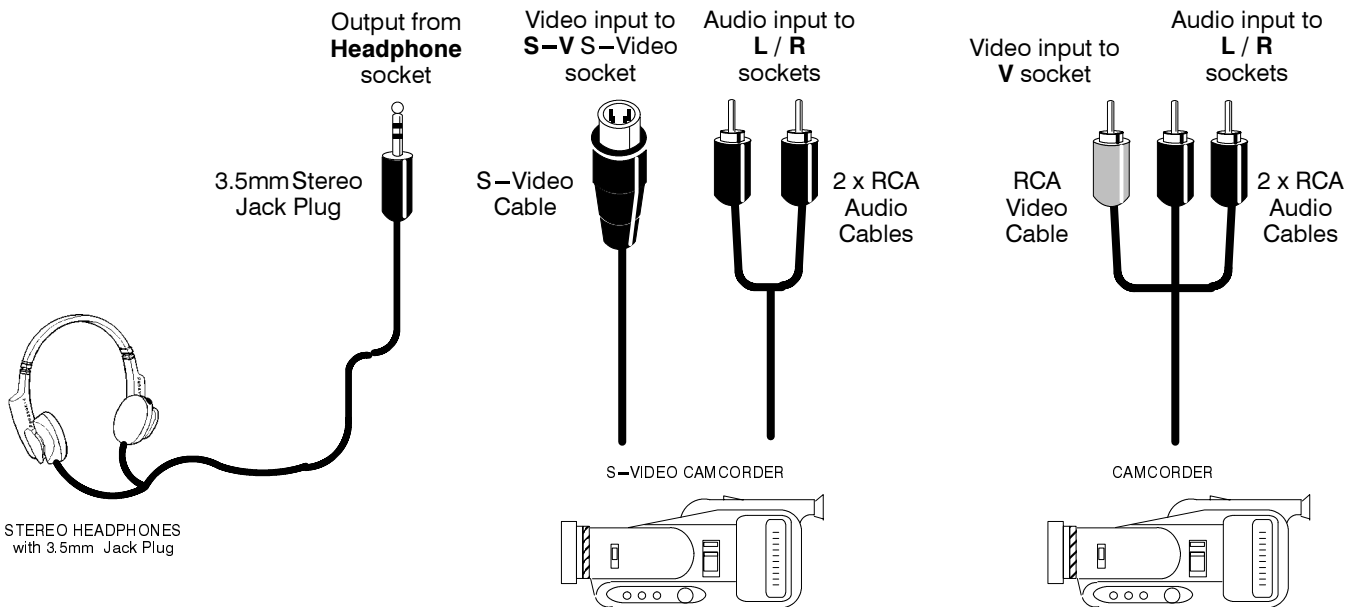
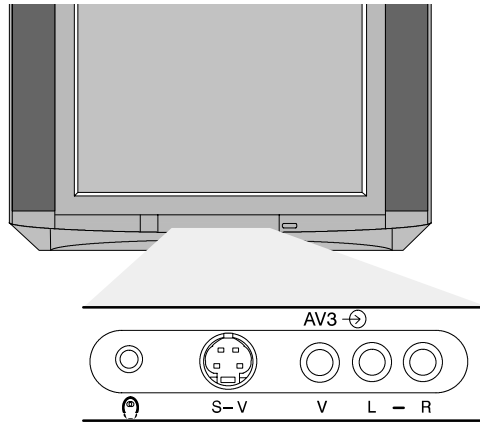

Notes :

- Ancillary equipment and cables shown are not supplied with this TV set.

■ SCART and S-Video Terminal Information

AV1 21 pin SCART terminal

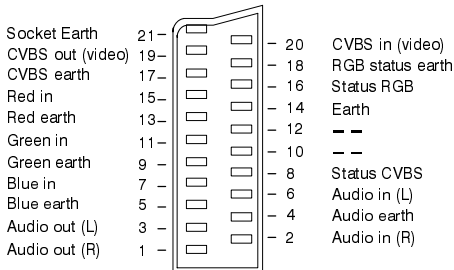

AV2 21 pin SCART terminal

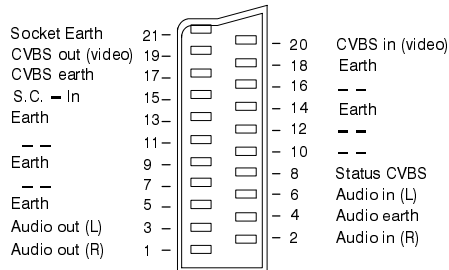

S-Video 4 pin terminal

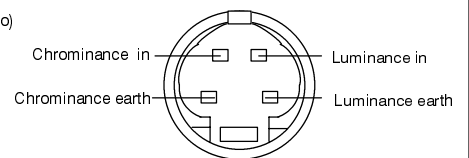

Suitable inputs for AV1 include RGB (Red/Green/Blue).

AV2 - Pins 15 and 20 are dependent on AV2 S-VHS / VIDEO switching.

AUDIO/VIDEO CONNECTIONS

Rear AV1/AV2(S) 21 Pin SCART and RCA Audio Out Terminals

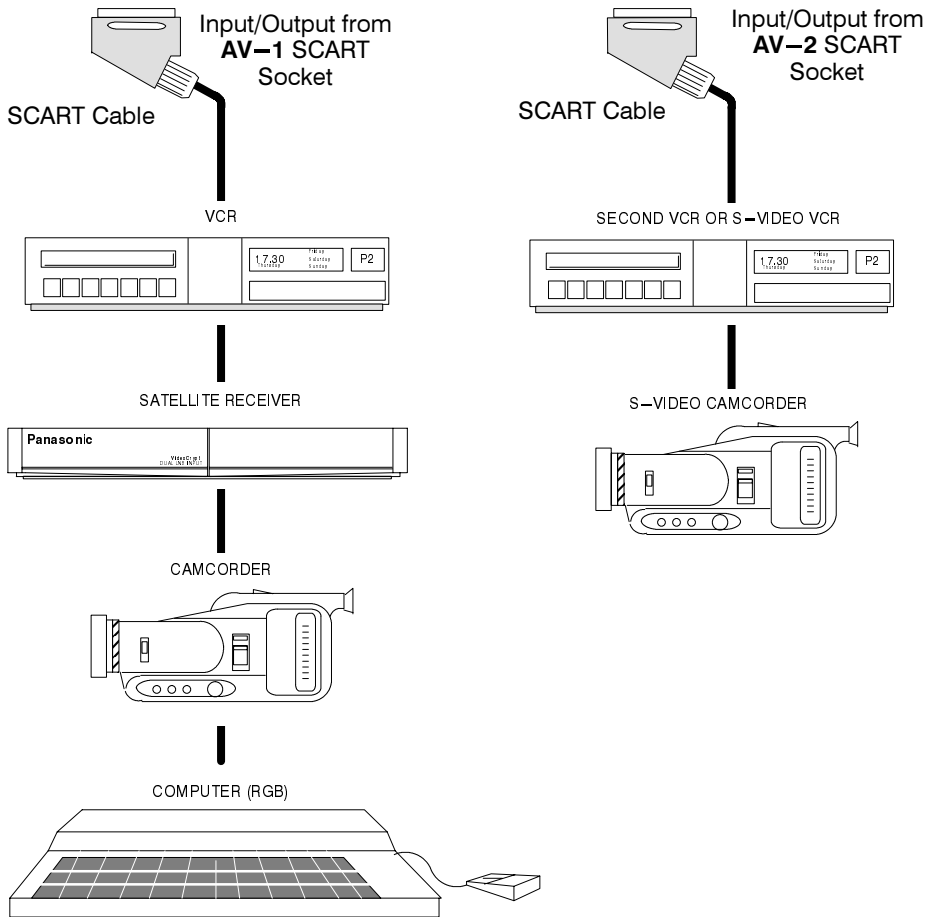
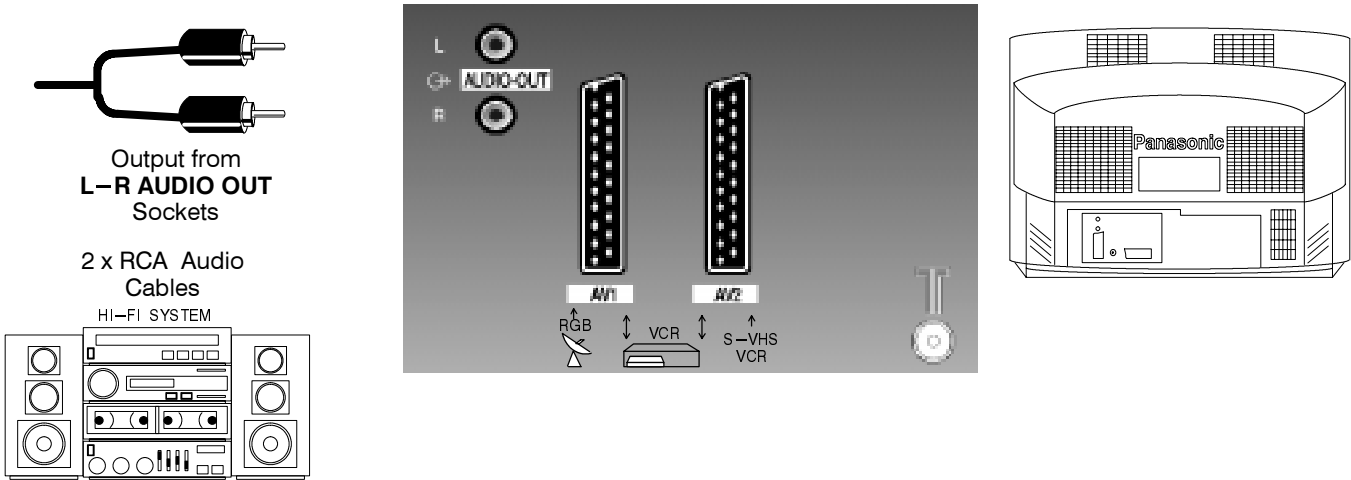







NOTES:

Ancillary equipment and cables shown are not supplied with this TV set.

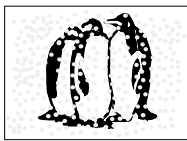
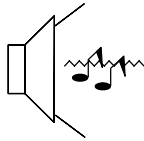
Do not connect a computer with TTL output (5V) to this set.

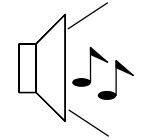
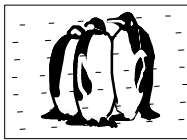
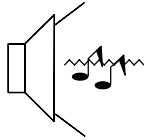
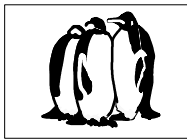
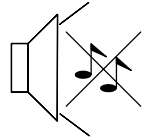
The AV2 21 pin terminal can also be used as an Output to Audio / Video Equipment (refer to page 10 for details).

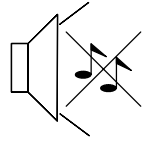
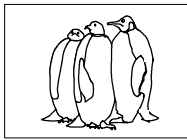
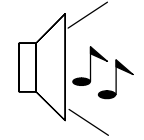
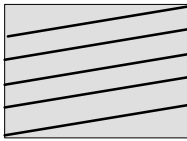
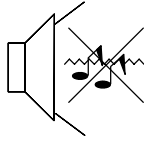
TROUBLESHOOTING

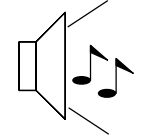
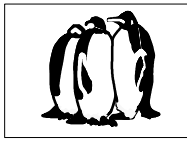
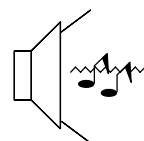
Symptoms		Checks
Picture	Sound	
 Snowy Picture	 Noisy Sound	Aerial location, direction or connection
 Multiple Images	 Normal Sound	Aerial location, direction or connection
 Interference	 Noisy Sound	Electrical appliances Cars / Motorcycles Fluorescent lights Switch on Noise-R in Setup menu to reduce picture noise
 Normal Picture	 No Sound	Volume level Sound mute switched on
 No Picture	 No Sound	TV set to AV mode Not plugged into A.C. outlet Not switched on Picture / Sound controls set at minimum levels Check if in standby mode
 No Colour	 Normal Sound	Colour controls set at minimum levels
 Poor or Distorted Picture	 Weak or No Sound	Retune Channel(s)
 Coloured Patches	 Normal Sound	Magnetic Interference from unshielded equipment Receiver moved while switched ON, switch TV off for 30 minutes.
 Normal Picture	 Weak or distorted sound	Sound reception may have deteriorated. Switch MPX setting (Sound menu) to Mono until reception improves.

